

DETAIL A

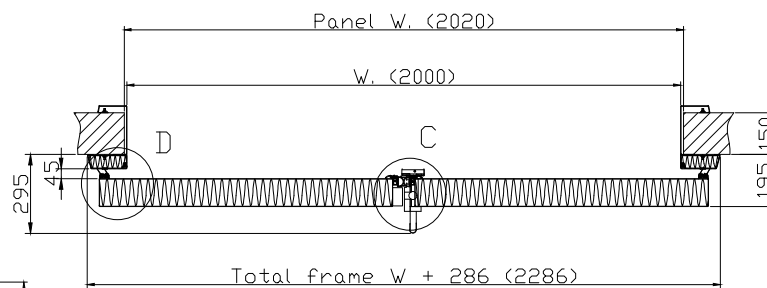

DETAIL C

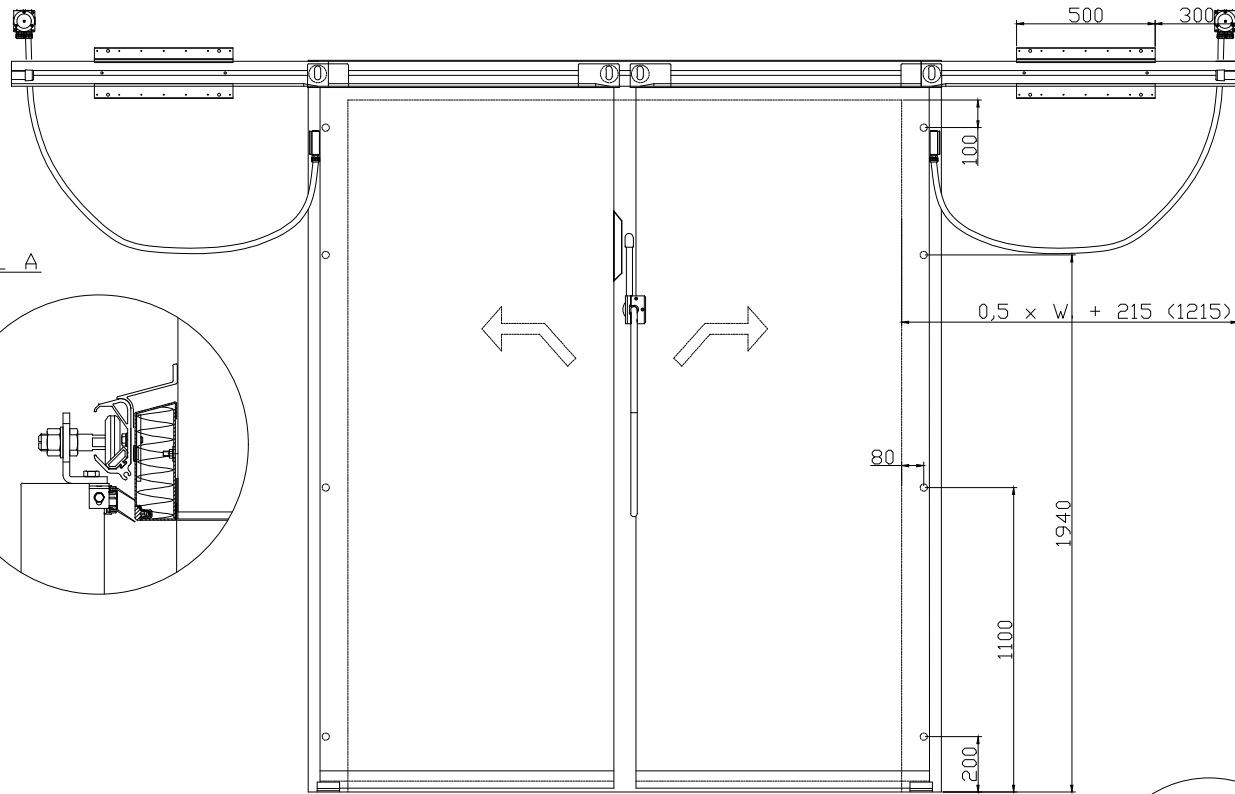
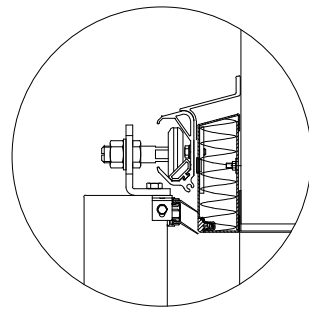
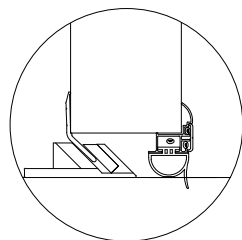
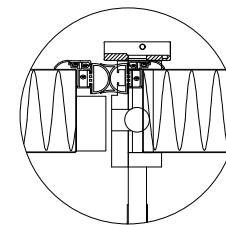

DETAIL B

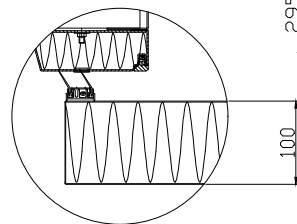

DETAIL D

Pos.	Antal.	Emne.	Tg.nr.	Materiale
Dato	Revision	Sign.	Thet:	Målforklart: Utdragsliste: Anmerk
			MS1002FH	Legem: DS
			Dan-doors	Prod.pak.date: Anmerk
				Tyldate: 160824
				Prod.pak.date: Anmerk
				Prod.pak.date: Anmerk
DAN-doors Havn 2200 København S Tlf: +45 33202000 Fax: +45 33202000				Filnavn: Tegnr: MS1002FH